

Article number: 20171B502BL

Description: E+G

Corner base clamps GN167-B50-2-BL

## Measures

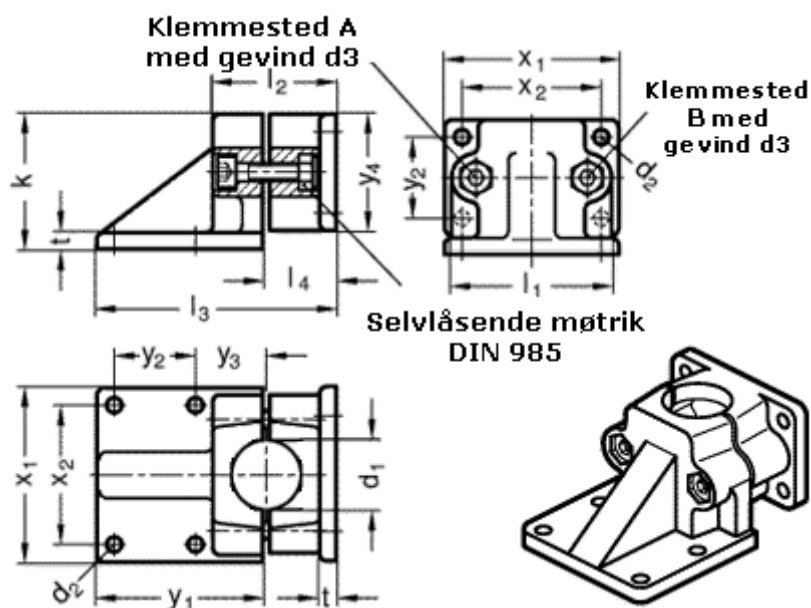

d1 = B50	t = 14
d2 = 11	x1 = 115
d3 = M10	x2 = 90
k = 91	y1 = 108
l1 = 98	y2 = 50
l2 = 82	y3 = 45
l3 = 156	y4 = 76
l4 = 47	